

Product Description

Thank you for purchasing Solid Apollos' Waterproof 4 Channel DMX to RGBW LED Controller. It is a new standard in DMX to RGBW or RGBA 4 Channel DMX Interfaces. If you currently have a DMX512 controller or any DMX capable control unit, this is the perfect device for controlling RGB/RGBW products, like RGB LED strip, RGB lamps etc. You may also easily daisy-chain multiple units for additional RGB/RGBW outputs.

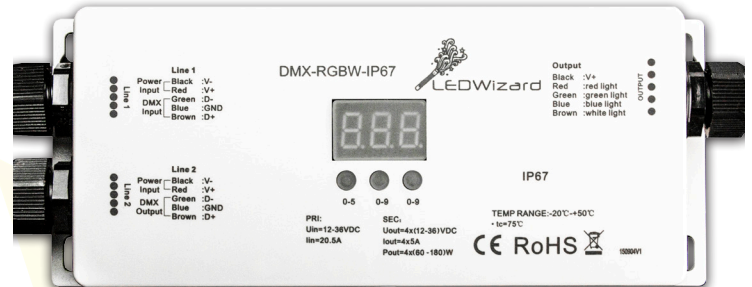

This DMX to RGBW LED Controller converts DMX signals to RGBW in a seamless and easy-to-use way. This second generation receiver/controller has a 3-Digit LED Display which makes it simple to set: DMX addresses, channel assignments, refresh rates and dimming configurations.

Features

- 1 to 4 channel configuration
- Waterproof to IP67
- High refresh rates
- Converts DMX signals to Single Color, Two Color, RGBW or RGBA formats
- Easy to use digital readout
- DMX512 compatible
- DMX Address selection LED display
- Logarithmic and Linear dimming options
- DMX & power IN and OUT
- RoHs, CE certified
- 12, 24, and 36 Volt operation
- 3 year warranty

Contents

Product Description and Features	1
Installation	2
Connecting Multiple Controllers	2
Using your DMX to RGBW Controller	3
Channel Operation	3
DMX Address Selection	4
Setting the Refresh Rate	5
Setting the Dimming Options	5
Trouble Shooting	6
Technical Parameters	6

Installation

Solid Apollos' Waterproof 4 Channel DMX - RGBW LED Controller acts as an interface between a DMX controller or RGB/RGBW Lighting fixture(s). This part of the Product Manual will show you how to utilize your 4 Channel DMX- RGBW controller with a DMX system, in both standard RGB (three channel operation) and RGBW (four channel operation) as well as One and Two Channel modes.

1. To wire the RGB or RGBW LED lighting fixtures you wish to control, connect your wires according to the diagram below. Note the positions of the negative wires and the positive wires. Be sure to wire your White/ Yellow lighting connections of your RGBW fixture(s) to the appropriate color coded wire connections on the right of the controller.
2. Connect 12-36 Volts of DC power to the LED lights you are using taking note of the Red (positive) and Black (negative) connections. Be aware of the power required by the number of lighting fixture you are using. This specific controller can operate normally with a maximum 240Watts of power at 12V, or 480 Watts at 24V. Connect your power supply wiring as shown below noting the positive and negative receptacles.
3. Once your 4 Channel DMX- RGBW LED Controller is wired with power and your RGB(W) lighting fixture(s) you can connect your DMX-In wires. To do this, attach them to the specified wires in Figure 1.
4. Make sure the ground wire is attached to one of the negative power.
5. Installation is complete and we can now turn on our device.

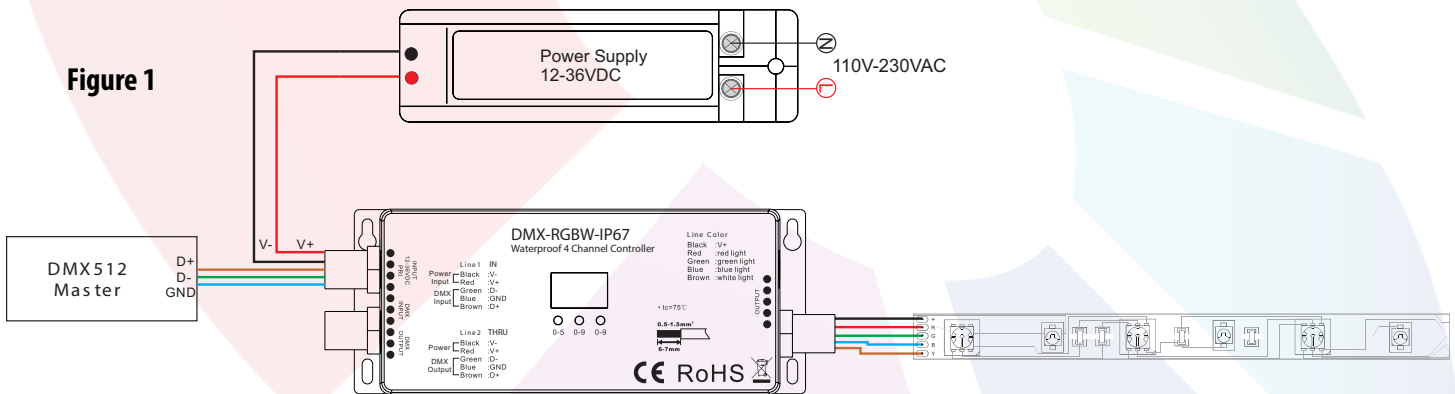

Connecting Multiple Controllers

You may easily daisy-chain multiple controllers (a maximum of 512 units) by connecting the DMX I/O and Power using the included connection wires. Each unit will require a unique DMX address.

See Setting DMX Addressing on the following page.

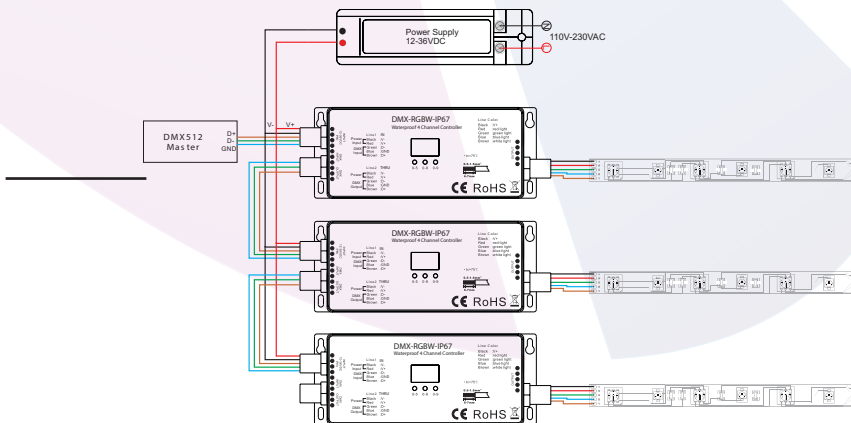

Using your DMX to RGB-W LED Controller

This section will show you how to turn on your 4 Channel DMX-RGBW LED Controller, select 1 to 4 Channel operation, and select the specific DMX Address on your controller.

Note: This 4 Channel DMX-RGBW LED Controller will always be in a DMX512 mode and will always require a DMX signal for normal operation.

Powering your Controller

To power on your controller, simply connect a 12-36V DC transformer such as the Solid Apollo 24V-4A-96W (SKU: SA-PS-24V-4A-96W) to the controller. Your Controller will remain on as long as it is plugged in. Be sure to have the controller powered before initializing DMX software or hardware-based signal generator.

Selecting 1-4 Channel Operation

1. You can switch between 1, 2, 3, and 4-Channel Operation depending on the type of fixture you are using.

- 1 Channel** - for use with single color LED fixture
- 2 Channel** - for use with Dynamic White or other two channel fixture
- 3 Channel** - Standard RGB fixture
- 4 Channel** - for use with RGBW, RGBA or other four channel fixture

2. After holding down buttons 2 and 3 for ten seconds, you will see "4CH"; this means you are in 4-Channel Mode - the factory default.
3. To switch between 1, 2, 3, and 4 Channel modes, simply press Button 1 to cycle through the modes. Once you have selected the mode that corresponds to your LED lighting fixture, simply press and hold any button to confirm for ten seconds.

Also see DMX Addressing and how it relates to channel assignments - on the following page.

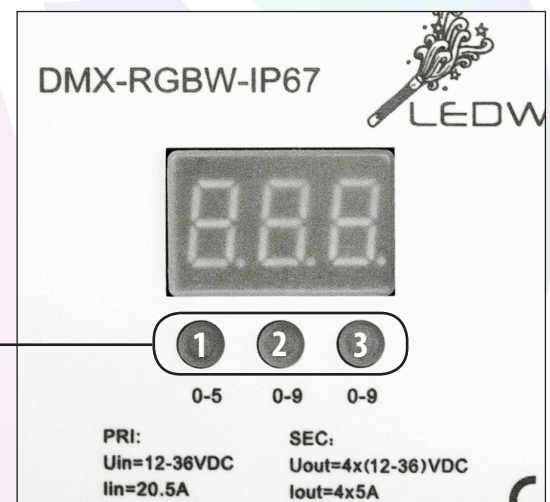

Assigning a DMX Address

1. To select a DMX address for your controller, you can use Button 1 to select the hundreds value. By pressing button 1, you can change the first digit i.e. - 100, 200, 300, 400, and 500 series of addresses. For example. If the address 318 is being displayed on your controller, by pressing the first button one time would then give a reading of 418.
2. In the same way you can change the hundreds digit for your DMX address using button one, you can also change the ten and single digit address numbers using the second and third buttons on your controller, respectively. To change the tens digit, simply press button 2. If the display has 112 displayed, pressing the second button once will show 122. Now, if the third button is pressed, the display will read 123.

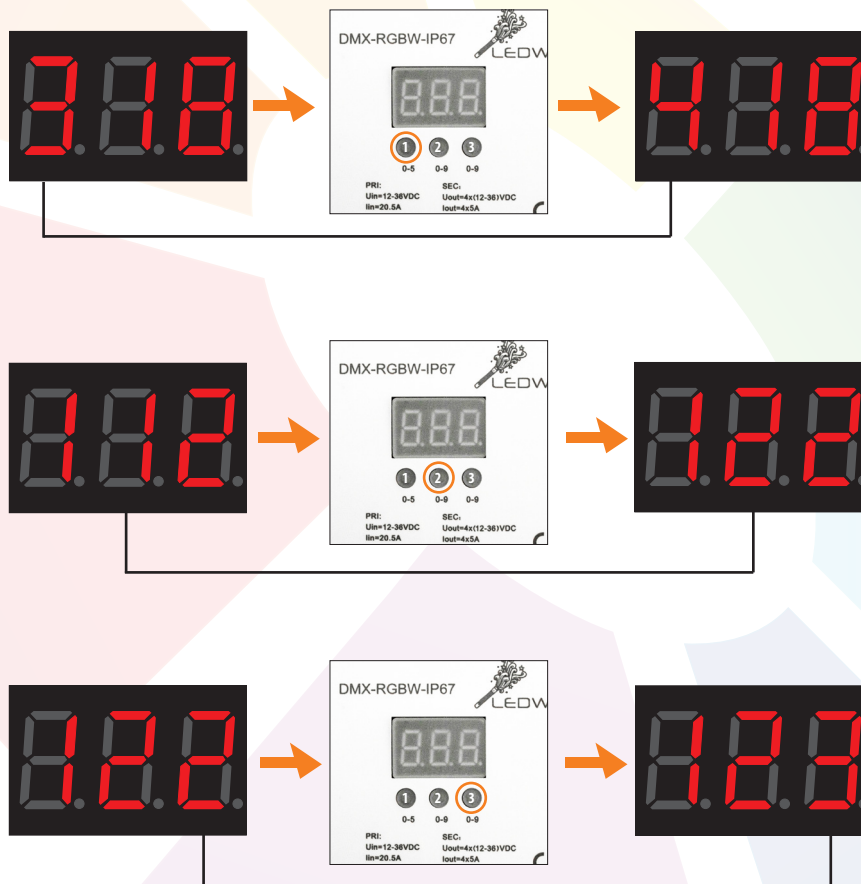

Note: If you are configuring more than one controller, their DMX addresses must be unique unless they are to be linked. For example, if the first unit is in 4-Channel Mode (RGBW), then it will use the first four available channels - 1 thru 4, and its DMX address would be 001; and if the second controller is in 3 Channel Mode (RGB), then its DMX address would be 005 (the next available channel) and its channel assignments would then be 5, 6 and 7 (three channels for RGB) - and so on. This way, the DMX software or DMX hardware-based signal controller knows exactly what number is assigned to a particular channel on a given fixture(s).

Setting the Refresh Rate

This four channel DMX to RGBW controller can switch between 200Hz and 1500Hz refresh rate or PWM frequency.

To change the refresh rate:

1. Hold down buttons 1 and 3 for five seconds. You will see **P-c** flash.
2. Then press button 3 and you will see **P-1**.
“c” indicating you are in the Refresh menu. “2” indicating the controller is set to 200Hz - the factory default.
3. Continuing to press button 1 while in Refresh mode will toggle between 1 and 2 being 200Hz and 1500Hz.



What is the Refresh Rate

Powering LEDs with driver refresh rates below 240Hz can interfere with a video signal, causing phase distortion or flickering when the light source is in the cameras field of view.

A low refresh rate can also cause a shutter effect when an LED is physically in motion.

This 4 channel DMX to RGBW controller can process refresh rates up to 1500Hz with no image flickering what so ever, making it the perfect choice for studio accent lighting or stage lighting; any environment where video is to be broadcasted or recorded. Not all LED fixtures will benefit from high refresh rates and may actually dim if the rate is too high.

Setting the Dimming Curve

This four channel DMX to RGBW controller can switch between a logarithmic and linear dimming curve.

To change the dimming curve:

1. Hold down buttons 1 and 3 for five seconds. You will see **P-c** flash.
2. Then press button 1 and you will see **1-c**. “P” indicating you are in the Dimming Curve menu. “2” indicating the controller is set to Linear - the factory default.



What is a Dimming Curve

The dimming curve indicates the rate at which a lighting fixture will dim between 0% and 100%. A linear curve indicates an equal rate between the highest and lowest values, making it a good choice for software-based automated control. A logarithmic curve indicates a slower dimming rate at the highest and lowest ranges, allowing for finer control in the upper and lower levels and making it a good choice for non-automated or “static” light settings where more control over dimming is needed.

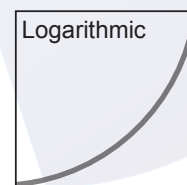
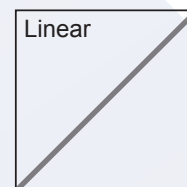

Troubleshooting

DMX signal not received

1. First Check to make sure your DMX wires are connected to the DMX IN, and not to the DMX OUT ports on the left side of your controller. The DMX OUT ports do not receive signal and will not work as inputs from a DMX controller (Refer to Figures 1 & 2).
2. Be sure the controller is set it to the Correct 3-Channel or 4-Channel operation based on your LED Lighting Fixture, and that you have a proper DMX address.

White LED Light Channel Not Functioning.

1. Your 4 Channel DMX-RGB-W LED Controller will only send signals to the white Channel in DMX Mode. Therefore if it is set in RGB Control Mode, and it is cycling through colors, you will not be able to utilize the White Channel.
2. If your white channel is not being utilized, make sure it is set to "4ch" mode as described on page 3. If it is in "3ch" mode (3-channel mode) it is only receiving signals for the Red, Green and Blue Channels of your RGB portion of your RGB-W Lighting Fixture(s).

Technical Information

Waterproof 4 Channel DMX to RGB-W LED Controller

- 12-36V DC Operation
- Up to 5A per channel
- 1-4 Channel Operation (Single Color, Dynamic White - two color, RGB and RGBW)
- Max 240 Watts of power @ 12V DC
- Max 480 Watts of power @ 24V DC
- IP67
- DMX 512 Operation
- DMX Channels: 512
- Size: 7.09 x 1.5 x 2.88 Inches
- Weight: .3 Pounds
- 30-115°F

SKU: SA-CTRL-DMX-RGBW-IP66